

SIDE VIEW

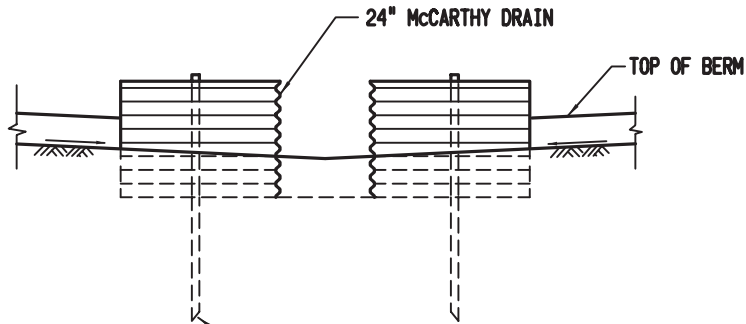

INSTALL ONE 5' GALV. ANCHOR STAKE ON EACH SIDE OF MC CARTHY TYPE DRAINS. ATTACH WITH 8 GAUGE GALV. WIRE THROUGH 2 PUNCHED HOLES OR $\frac{1}{2}$ " x 1' GALV. BOLT THROUGH $\frac{9}{16}$ " HOLE, TYP.

FRONT VIEW A-A